

SPINNER II®

OIL CLEANING CENTRIFUGE

Model 576HE

Installation Instructions

Parts List

Service Instructions



Three connections are required at the centrifuge:

1. Oil Inlet (1/2-in. NPT Female Pipe) — *Unscrew plastic shipping plug.* Run #8 hose from point of highest pressure.
2. Oil Outlet (1/2-in. NPT Female Pipe) — *Unscrew plastic shipping plug.* Run #8 hose to crankcase above oil level.
3. Air Inlet (1/4-in. NPT Female Pipe) — *Unscrew plastic shipping plug.* Run #4 hose from any convenient point on air supply to air valve cartridge inlet. *Do not remove cartridge — loss of cartridge seal may damage unit.*

CAUTION — Route hoses to clear exhaust and all moving parts and fasten securely. Be certain the pressurized oil supply is to OIL IN port on side of centrifuge and return to crankcase is from OIL OUT port on bottom. *Do not remove full-flow filters.* Use the Spinner II centrifuge only as a bypass oil cleaner. Remove any previously installed bypass filters prior to installation of the Spinner II, and block ports where necessary.

Detailed Information Available

For optimum performance of your centrifuge, specific installation drawings for almost any diesel engine can be requested from Spinner II Products.

General Instructions

Dirty Oil Supply to Centrifuge Oil Inlet

Pressure Tap on Engine — Most engines, including the latest models from Cummins, Caterpillar, DDC and Mack, provide a 3/8-in. or 1/2-in. port to supply an auxiliary device. Avoid using end-of-gallery supply points such as the pressure gauge tap.

Clean Oil Outlet Return to Crankcase

Return Opening in Crankcase — Most engines have a 1/2-in. or larger oil return opening provided in the crankcase wall. If unrestricted, this is an ideal oil outlet line connection point.

Special Return Problems — If there are no available drain openings, it may be necessary to drill and tap an inspection plate. Remove the plate before modification and avoid directing the return flow directly onto moving parts. Request assistance from Spinner II Products.

Air Supply

Air for the control mechanism can be taken from any convenient place on the vehicle air system where there is a constant supply of air, preferably from the dry tank. 1/8-in. nylon tubing is sufficient or #4 hose can be used if preferred. Air pressure can vary from 35 to 125 psig. If over 125 psi, a regulator must be used. The Spinner II control automatically shuts off the air supply when the engine stops. Air consumption of 0.02 SCFM is almost too small to measure.

Note: The control mechanism can be operated on bleed air taken from the turbocharger manifold if compressed air is not available. The standard air valve must be replaced by Part #72137 low-pressure air valve cartridge which includes a pre-filter Part #71246. Request Bulletin 86.020 for details.

Spinner II/576HE Net Weight 10 lb (4.5 kg)

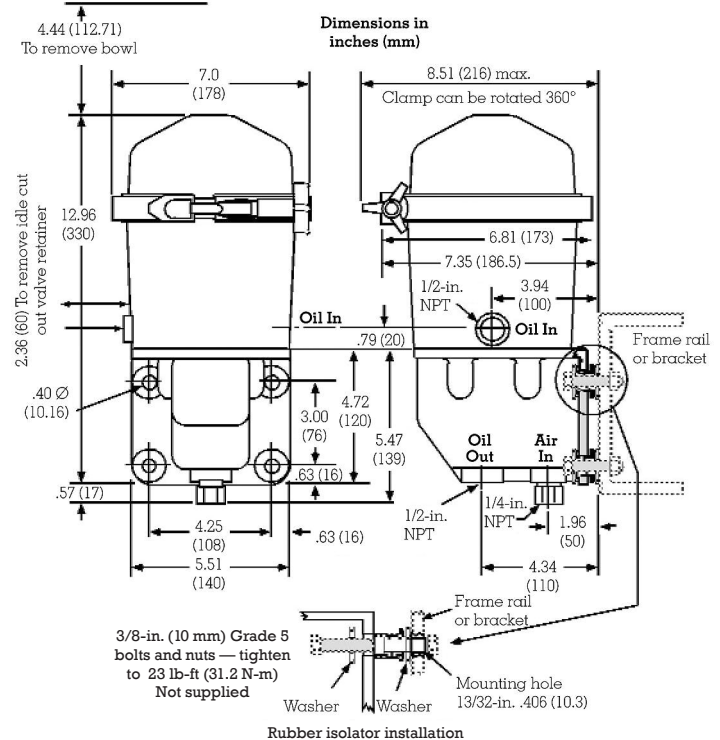

Mounting Location

Install at no more than 15° from vertical (temporary increases in tilt angle from vehicle operation are not significant). The frame rail is the preferred location for mounting the centrifuge. Check with manufacturer before drilling. Bulletin 71294 contains a drilling template. Mounting the centrifuge directly to the engine is not recommended. The Spinner II centrifuge is a high-speed device and is provided with rubber isolators for operator comfort, which must be installed as shown above. Care should be used to prevent metal-to-metal contact with the frame or body, which might result in unnecessary noise or vibration. The cover clamp can be rotated to any convenient position and *tightened by hand only*.

Model 576HE Parts List

Item Description Part number
 Only items shown with part numbers are available.

Centrifuge, Spinner II/Model 576HE complete 73665

Centrifuge, Spinner II/Model 576HE, without LCB 73663

Service kit (1 each items c and d) 73642

a Cover assembly 73640

b Band clamp 73715

c O-ring (Viton) 73740

d RotorPart of Service Kit 73642

e M10 x 35 bolts 73716

f Body assembly 73641

g Cut-out valve kit 73741

h Seal-idle cutout valve 73750

i Lower bearing kit 73786

j O-ring (Viton) 73742

k Repair kit-control float mechanism 73964

l Drain body assembly 73963

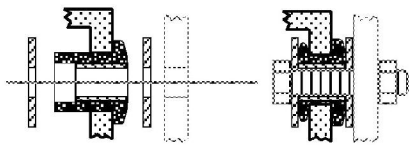

m Kit-isolator, rubber, with washers (set of 4)
 (3/8-in. grade 5 bolts and nuts not supplied) 73965

n Seal-air valve cartridge, Viton 73966

o Cartridge-air valve assembly (includes item n) 73967

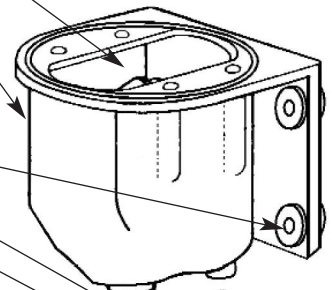
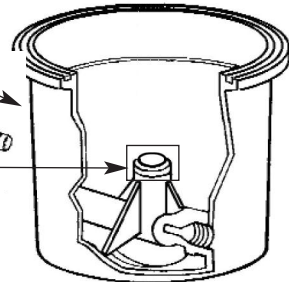
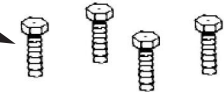
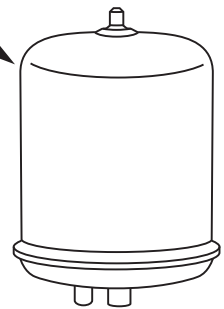
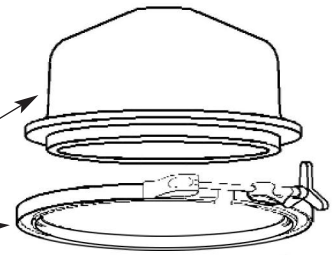

Refer to Parts List illustration

1. Shut off engine and allow centrifuge rotor **(d)** to come to a complete stop. This centrifuge will contain hot oil so proper precautions must be taken to prevent burns.
2. Loosen handle on band clamp **(b)**, disengage tee bolt and remove cover assembly **(a)**, using a coin in the gap to separate the cover from the body assembly **(f)**.
3. Remove the rotor **(d)** and allow it to drain. This rotor is not serviceable and cannot be opened.
4. Clean and inspect the cover assembly **(a)**. Always remove the old seal **(c)**. Clean the groove in the housing and mating surface of the cover and replace the old seal with a new Viton O-ring **(c)**.
5. Inspect the bearings in the cover **(a)** and the body assembly **(f)** to make sure they are free of debris (See Trouble-Shooting below).
6. Insert a new rotor **(d)** into the cover assembly **(a)** and firmly press until it seats.
7. Align rotor **(d)** inlet with the bearing in the body assembly **(f)** and press the two pieces together. The cover assembly **(a)** should rest on the O-ring on the body assembly **(f)** if the centrifuge has been assembled correctly.
8. Position band clamp **(b)** uniformly over the cover and body flanges and tighten clamp handle securely by hand pressure only.
9. With the engine running, check all connections and joints for leaks.
10. Visually inspect the rubber isolators **(m)** for deterioration. Replace any isolators that show deterioration. Torque the fasteners to the proper 23 ft-lbs (31.2 Nm) as the rubber isolators **(m)** will be damaged if too much torque is applied to the fasteners.

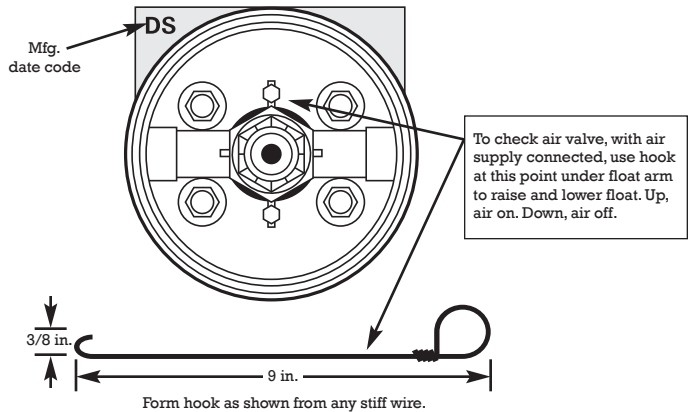

Figure 1. Top view with rotor removed

Trouble-Shooting

Problem: Excessive vibration Excess noise from centrifuge

Solution: Inspect Bearings (Step 5)

The top bearing cannot be replaced. If it is found to be bad, a replacement cover assembly **(a)** will need to be purchased. The lower bearing **(i)** can be replaced using Part 73786. To replace this assembly, you will need a 29mm socket to remove the plastic housing. The steel sleeve insert will need to be removed if it did not come out with the housing, as well as the spacer washer that is under the other parts. Once all parts have been removed, clean the recess. Insert the new brass bearing into the plastic housing from the bottom (threaded) side and press until it seats. Rotate the brass bearing until the hole is aligned with the hole in the housing. Insert the steel sleeve into the brass bearing. Place the new washer into the centrifuge body recess and then thread the other three parts back into the metal housing using Loctite 648. Tighten to 11 lb-ft torque.

Problem: Control air valve problems Float valve flows air constantly or not at all, up or down Air tank bleeds down overnight

Solution: Check Valve

Most air control problems can be repaired without dismantling the centrifuge by renewing the air valve cartridge **(o)**, making certain that air valve cartridge seal **(n)** is in place. A cartridge installed without the seal will be damaged and will leak continuously. If the float mechanism is worn or broken, the centrifuge must be disassembled and repaired with control float mechanism repair kit **(k)**. Instructions are contained in the kit.

Problem: Oil leaks

Solution: Replace Cover Seal

Remove cover **(a)** and cover seal **(c)**. Clean seal grooves in housing and mating surface on cover. Install a new cover seal **(c)** in the housing groove, replace cover **(a)**, position clamp **(b)** uniformly over cover and housing flanges, and tighten clamp handle securely by hand pressure

Solution: Replace Body-to-Control-Mechanism Seal

Remove cover and centrifuge turbine assembly. Remove control mechanism by loosening four cap screws. Discard seal **(j)** and clean groove and mating surfaces. Replace seal with a new one and retighten cap screws alternately to 35 lb-ft torque. It is possible to rotate the body 180° if it is necessary to locate the oil inlet port on the left side. Replace the seal and retighten bolts. Continue from Step 3 above.

Solution: Inspect Oil Line Connections

Disconnect leaking hose and remove hose adapter from port. Clean threads in port and on adapter, and inspect for damage. Reinstall adapter using a good liquid thread sealant. Reconnect hose.

Sales and Service

SPINNER II®
PRODUCTS



T. F. HUDGINS
INCORPORATED

Tel: 713-682-3651 or 800-231-7746
 Fax: 713-681-9702
 Mail: P.O. Box 920946
 Houston, Texas USA 77292-0946
 Warehouse: 4405 Directors Row
 Houston, Texas USA 77092
 Web Site: www.Spinnerii.com